

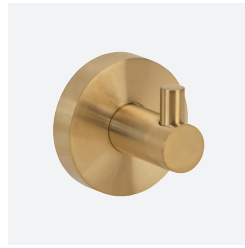

Brilo
1—4



Sablo
5—8



Hotel
9—12



Cytro
13—16



Home
17—22



Coral
22



Amber
22



Hematit
22



Graphit
22



Dark
23



Solo
23



Nero
24



White
24



Organic
24



Beta
24



Косметические зеркала
Cosmetic mirrors
Kosmetikspiegel
Косметические зеркала
24

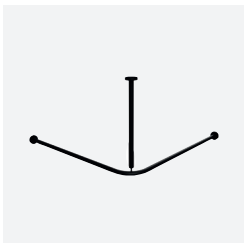

Душевое оборудование
Shower equipment
Dusch - Zubehör
Душевое
оборудование
24

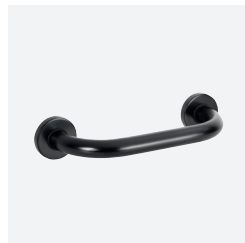

Help program
25—27

Brilo

1



Mosaz | Brass | Messing | Латунь
Lesk | Polished | Poliirt | Блеск

Sklo | Glass | Glas | Стекло
Mat | Matt | Matt | Мат

PVD





161106020

55 × 55 × 50 mm

Háček

Hook

Kleiderhaken

Крючок



161106032

55 × 55 × 50 mm

Háček dvojité

Double hook

Doppelkleiderhaken

Крючок двойной



161315010

205 × 260 × 205 mm, 5 l

Odpadkový koš s víkem „Soft Close“

Trashbasket „Soft Close“

Abfalleimer „Soft Close“

Мусорный ящик „Soft Close“



161108042

110 × 55 × 105 mm

Mýdlenka skleněná

Glass soap dish

Glasseifenablage

Мыльница стеклянная



161109102

75 × 145 × 100 mm, 200 ml

Dávkoč mýdla

Soap dispenser

Seifenspender

Дозатор жидкого мыла



161110012

70 × 95 × 105 mm

Držák kartáčků

Toothbrush holder

Zahnbürstenhalter

Держатель зубных щеток

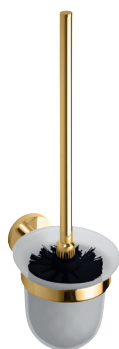

161113017

95 × 360 × 140 mm

WC štětka

Toilet brush

WC-Bürstengarnitur

Ёршик подвесной (стекло)



161313060

95 × 380 × 105 mm

WC štětka na postavení/nástěnná

Toilet brush free standing/hanging

WC-Bürstengarnitur stehend/hängend

Ёршик подвесной/напольный

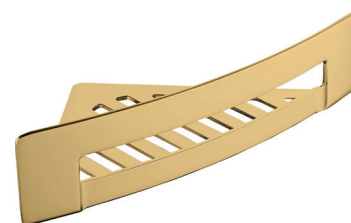

161208280

280 × 75 × 160 mm

Polička do sprchy rohová

Corner shower shelf

Duschregal

Душевая полка



Brilo



161112042

140 × 95 × 90 mm

Držák toaletního papíru bez krytu

Toilet paper holder without cover

Papierrollenhalter ohne Deckel

Держатель туалетной бумаги без крышки



161112010

140 × 155 × 80 mm

Držák toaletního papíru s krytem

Toilet paper holder with cover

Papierrollenhalter mit Deckel

Держатель туалетной бумаги с крышкой



161212030

175 × 55 × 70 mm

Držák toaletního papíru pravostranný

Toilet paper holder, rightward

Papierrollenhalter, recht

Держатель туалетной бумаги, правый



3



161112030

55 × 165 × 65 mm

Držák toaletního papíru rezervní

Spare toilet paper holder

Reservepapierrollenhalter

Держатель запасного рулона



161204190

55 × 55 × 420 mm

Držák ručníků dvojitý otočný

Double towel holder swivel

Doppelhandtuchhalter schwenkbar

Полотенцедержатель двойной поворотный



161307611

350 × 50 × 75 mm

Madlo pevnostní

Bath grab bar

Wannengriff

Поручень прямой



161204020

505 × 55 × 65 mm

Držák ručníků

Towel holder

Handtuchhalter

Полотенцедержатель



161204042

655 × 55 × 65 mm

Držák ručníků

Towel holder

Handtuchhalter

Полотенцедержатель



161204052

655 × 55 × 120 mm

Držák ručníků dvojitý

Double towel holder

Doppelhandtuchhalter

Полотенцедержатель двойной





Sablo

5



Mosaz | Brass | Messing | Латунь
Mat | Matt | Matt | Мат

Sklo | Glass | Glas | Стекло
Mat | Matt | Matt | Мат

PVD





160106020

55 × 55 × 50 mm

Háček

Hook

Kleiderhaken

Крючок



160106032

55 × 55 × 50 mm

Háček dvojité

Double hook

Doppelkleiderhaken

Крючок двойной



160315010

205 × 260 × 205 mm, 5 l

Odpadkový koš s víkem „Soft Close“

Trashbasket „Soft Close“

Abfalleimer „Soft Close“

Мусорный ящик „Soft Close“



160108042

110 × 55 × 105 mm

Mýdlenka skleněná

Glass soap dish

Glassseifenablage

Мыльница стеклянная



160109102

75 × 145 × 100 mm, 200 ml

Dávkoč mýdla

Soap dispenser

Seifenspender

Дозатор жидкого мыла



160110012

70 × 95 × 105 mm

Držák kartáčků

Toothbrush holder

Zahnbürstenhalter

Держатель зубных щеток



160113017

95 × 360 × 140 mm

WC štětka

Toilet brush

WC-Bürstengarnitur

Ёршик подвесной (стекло)



160313060

95 × 380 × 105 mm

WC štětka na postavení/nástěnná

Toilet brush free standing/hanging

WC-Bürstengarnitur stehend/hängend

Ёршик подвесной/напольный

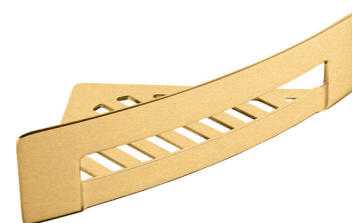

160208280

280 × 75 × 160 mm

Polička do sprchy rohová

Corner shower shelf

Duschregal

Душевая полка



Sablo



160112042

140 × 95 × 90 mm

Držák toaletního papíru bez krytu

Toilet paper holder without cover

Papierrollenhalter ohne Deckel

Держатель туалетной бумаги без крышки



160112010

140 × 155 × 80 mm

Držák toaletního papíru s krytem

Toilet paper holder with cover

Papierrollenhalter mit Deckel

Держатель туалетной бумаги с крышкой



160212030

175 × 55 × 70 mm

Držák toaletního papíru pravostranný

Toilet paper holder, rightward

Papierrollenhalter, recht

Держатель туалетной бумаги, правый



7



160112030

55 × 165 × 65 mm

Držák toaletního papíru rezervní

Spare toilet paper holder

Reservepapierrollenhalter

Держатель запасного рулона



160204190

55 × 55 × 420 mm

Držák ručníků dvojitý otočný

Double towel holder swivel

Doppelhandtuchhalter schwenkbar

Полотенцедержатель двойной поворотный



160307611

350 × 50 × 75 mm

Madlo pevnostní

Bath grab bar

Wannengriff

Поручень прямой



160204020

505 × 55 × 65 mm

Držák ručníků

Towel holder

Handtuchhalter

Полотенцедержатель



160204042

655 × 55 × 65 mm

Držák ručníků

Towel holder

Handtuchhalter

Полотенцедержатель



160204052

655 × 55 × 120 mm

Držák ručníků dvojitý

Double towel holder

Doppelhandtuchhalter

Полотенцедержатель двойной





Оборудование для гостиниц

Hotel equipment
Hotelzubehör

9



Nerez | Stainless | Edelstahl | Нержавеющая сталь
Mosaz | Brass | Messing | Латунь
Chrom | Chrome | Chrom | Хром
Sklo | Glass | Glas | Стекло
PVC
FE





105109020

97 × 150 × 93 mm, 500 ml

Dávkoč mýdla, nerez, černý

Soap dispenser, stainless steel, black

Seifenspender, rostfreier Stahl, schwarz

Дозатор жидкого мыла, нержавеющая сталь, черный



121209030

115 × 245 × 110 mm, 1000 ml

Dávkoč mýdla, plast, černý

Soap dispenser, plastic, black

Seifenspender, Plastik, schwarz

Дозатор жидкого мыла, пластик, черный



121209140

65 × 185 × 75 mm, 300 ml

Dávkoč mýdla, plast, černý

Soap dispenser, plastic, black

Seifenspender, Plastik, schwarz

Дозатор жидкого мыла, пластик, черный



124109290

140 × 235 × 102 mm, 1200 ml

Automatický dávkoč mýdla, plast, černý

Automatic soap dispenser, plastic, black

Automatischer Seifenspender, Plastik, schwarz

Автоматический диспенсер мыла, пластик, черный



124109330

140 × 235 × 102 mm, 1200 ml

Automatický dávkoč dezinfekce, plast, černý

Automatic disinfection dispenser, plastic, black

Automatischer Desinfektionsspender, Plastik, schwarz

Автоматический диспенсер для антисептика, пластик, черный



121209400

115 × 245 × 110 mm, 1000 ml

Dávkoč pěny, plast, černý

Foaming soap dispenser, plastic, black

Schaumseifenspender, Plastik, schwarz

Дозатор мыла-пены, пластик, черный



121209407

115 × 245 × 110 mm, 1000 ml

Dávkoč pěny, plast, šedý

Foaming soap dispenser, plastic, grey

Schaumseifenspender, Plastik, grau

Дозатор мыла-пены, пластик, серый



121109406

115 × 245 × 110 mm, 1000 ml

Dávkoč pěny, plast, bílý

Foaming soap dispenser, plastic, white

Schaumseifenspender, Plastik, weiß

Дозатор мыла-пены, пластик, белый



136109010

62 × 287 × 125 mm, 470 ml

Integrovaný dávkoč mýdla, černý

Built-in soap dispenser, black

Einbaseifenspender, schwarz

Встроенный дозатор жидкого мыла, белый





152109371

110 × 212 × 72 mm, 250 ml

Dávkovač mýdla se zámkem
 Soap dispenser, lockable
 Seifenspender
 Дозатор жидкого мыла с замком



152109381

136 × 212 × 72 mm, 2 × 250 ml

Dávkovač mýdla dvojitý se zámkem
 Double soap dispenser, lockable
 Doppelseifenspender
 Дозатор жидкого мыла с замком, двойной



139108192

90 × 18 × 90 mm

Mýdlenka na postavení
 Soap dish free standing
 Seifenablage frei stehend
 Мыльница отдельностоящая



139108342

98 × 15 × 98 mm

Mýdlenka na postavení
 Soap dish free standing
 Seifenablage frei stehend
 Мыльница отдельностоящая



113103030

270 × 260 × 115 mm

Zásobník na papírové ručníky, nerez, černý
 Hand towel dispenser, stainless steel, black
 Papierhandtuchspender, rostfreier Stahl, schwarz
 Диспенсер для бумажных полотенец, нержавеющая сталь, черный



148112050

200 × 215 × 117 mm, ø 200 mm

Bubnový zásobník papíru se zámkem, nerez, černý
 Jumbo-roll toilet paper dispenser, lockable, stainless steel, black
 Papierrollenspender, rostfreier Stahl, schwarz
 Диспансер для туалетной бумаги, нержавеющая сталь, черный



101915050

205 × 300 × 100 mm, 6 l

Odpadkový koš nástěnný, nerez, černý
 Waste bin wall mounted, stainless steel, black
 Abfalleimer wandhängend, rostfreier Stahl, schwarz
 Контейнер для мусора настенный, нержавеющая сталь, черный



101915110

250 × 500 × 250 mm, 25 l

Odpadkový koš nástěnný, nerez, černý
 Waste bin wall mounted, stainless steel, black
 Abfalleimer wandhängend, rostfreier Stahl, schwarz
 Контейнер для мусора настенный, нержавеющая сталь, черный

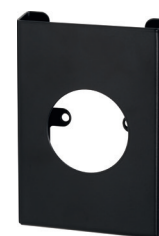

101403130

92 × 131 × 24 mm

Zásobník hygienických sáčků (HygBag), nerez, černý
 Hygienic bag dispenser (HygBag), stainless steel, black
 HygBag Spender, rostfreier Stahl, schwarz
 Держатель салфеток (HygBag) нержавеющая сталь, черный





101218010

33 × 30 × 33 mm

Dveřní doraz na zem, černý

Door stop on floor, black

Türstopper, schwarz

Дверной упор напольный, черный



101218020

18 × 18 × 80 mm

Dveřní doraz na stěnu, černý

Door stop wall-mounted, black

Türstopper an Wand, schwarz

Дверной упор настенный, черный



199100200

250 × 320 × 10 mm

Textilní sáček na fén

Hairdryer bag

Föntasche

Чехол для фена



201541050

56 × 150 × 490 mm

Konzole umyvadlová s držákem ručníků levá, černá

Washbasin console with towel holder leftward, black

Konzole für Waschbeckenplatte links, schwarz

Кронштейн для умывальника с полотенцедержателем левый, черный



40235

85 × 290 × 85 mm

Nádoba pro integrovaný dávkovač kompatibilní s výrobkem **15210912x** (1 l lahev, redukce závitů, hadička)

Container for integrated dispenser compatible with product **15210912x** (1 l bottle, thread reduction, hose)

Behälter f. integrierten Spender, kompatibel mit Produkt **15210912x** (1 l Flasche, Gewindereduzierung, Schlauch)

Запасная емкость для встроенного дозатора **15210912x** (1 л емкость, редукция резьбы, трубочка)



201541060

56 × 150 × 490 mm

Konzole umyvadlová s držákem ručníků pravá, černá

Washbasin console with towel holder rightward, black

Konzole für Waschbeckenplatte recht, schwarz

Кронштейн для умывальника с полотенцедержателем правый, черный



Cytro

13



Nerez | Stainless | Edelstahl | Нержавеющая сталь
Mosaz | Brass | Messing | Латунь
Plast | Plastic | Kunststoff | Пластик

Chrom | Chrome | Chrom | Хром
Lesk | Polished | Poliirt | Блеск
Brus | Brushed | Gebürstet | Мат
Lak | Painted | Lackiert | Лак





102308070

230 × 30 × 100 mm

Polička do sprchy, černá

Shower shelf, black

Duschregal, schwarz

Душевая полка, черная



102308120

245 × 60 × 150 mm

Polička do sprchy rohová, černá

Corner shower shelf, black

Eckseifenkorb, schwarz

Полочка для душа угловая, черная



153102390

290 × 47 × 220 mm

Polička do sprchy rohová, černá

Corner shower shelf, black

Eckseifenkorb, schwarz

Угловая полочка для мыла, черная



153308332

250 × 455 × 132 mm

Závěsný koš na baterii

Hang wire basket for tap

Seifenkorb zum Aufhängen

Подвесная полочка для душа





101302405

300 × 2 × 135 mm

Polička do spár, brus
 Shower shelf, brushed
 Eckduschablage, gebürstet
 Душевая полка, мат



101302401

300 × 2 × 135 mm

Polička do spár, lesk
 Shower shelf, polished
 Eckduschablage, poliert
 Душевая полка, блеск



101302400

300 × 2 × 135 mm

Polička do spár, černá
 Shower shelf, black
 Eckduschablage, schwarz
 Душевая полка, черная

15

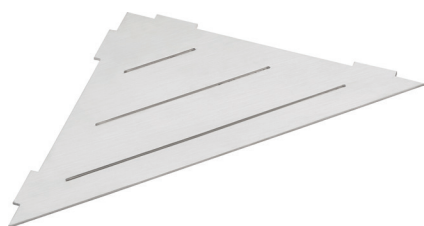

101302425

297 × 2 × 210 mm

Polička do spár, brus
 Shower shelf, brushed
 Eckduschablage, gebürstet
 Душевая полка, мат

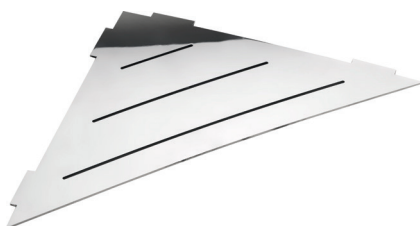

101302421

297 × 2 × 210 mm

Polička do spár, lesk
 Shower shelf, polished
 Eckduschablage, poliert
 Душевая полка, блеск

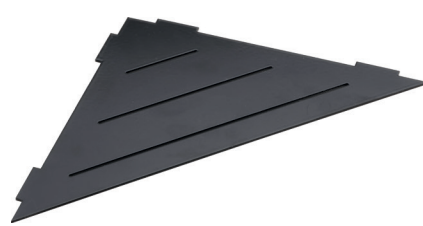

101302420

297 × 2 × 210 mm

Polička do spár, černá
 Shower shelf, black
 Eckduschablage, schwarz
 Душевая полка, черная



101302445

297 × 2 × 210 mm

Polička do spár, brus
 Shower shelf, brushed
 Eckduschablage, gebürstet
 Душевая полка, мат

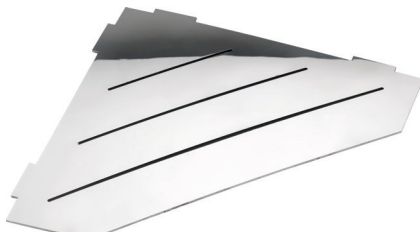

101302441

297 × 2 × 210 mm

Polička do spár, lesk
 Shower shelf, polished
 Eckduschablage, poliert
 Душевая полка, блеск

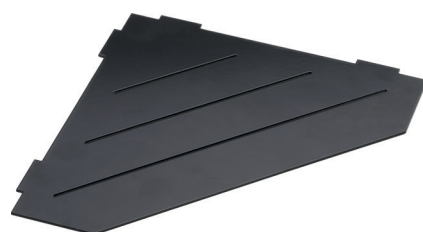

101302440

297 × 2 × 210 mm

Polička do spár, černá
 Shower shelf, black
 Eckduschablage, schwarz
 Душевая полка, черная



101302415

300 × 15 × 135 mm

Polička do spár, brus
 Shower shelf, brushed
 Eckduschablage, gebürstet
 Душевая полка, мат



101302411

300 × 15 × 135 mm

Polička do spár, lesk
 Shower shelf, polished
 Eckduschablage, poliert
 Душевая полка, блеск



101302410

300 × 15 × 135 mm

Polička do spár, černá
 Shower shelf, black
 Eckduschablage, schwarz
 Душевая полка, черная

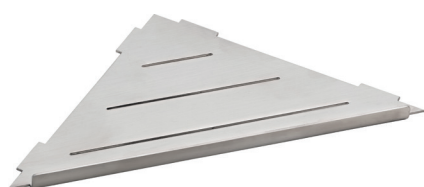

101302435

297 × 15 × 210 mm

Polička do spár, brus
 Shower shelf, brushed
 Eckduschablage, gebürstet
 Душевая полка, мат

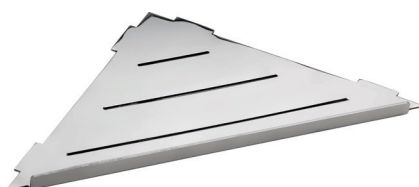

101302431

297 × 15 × 210 mm

Polička do spár, lesk
 Shower shelf, polished
 Eckduschablage, poliert
 Душевая полка, блеск

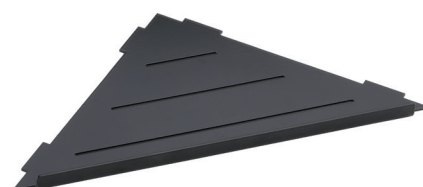

101302430

297 × 15 × 210 mm

Polička do spár, černá
 Shower shelf, black
 Eckduschablage, schwarz
 Душевая полка, черная



101302455

297 × 15 × 210 mm

Polička do spár, brus
 Shower shelf, brushed
 Eckduschablage, gebürstet
 Душевая полка, мат

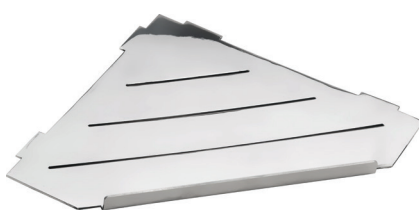

101302451

297 × 15 × 210 mm

Polička do spár, lesk
 Shower shelf, polished
 Eckduschablage, poliert
 Душевая полка, блеск

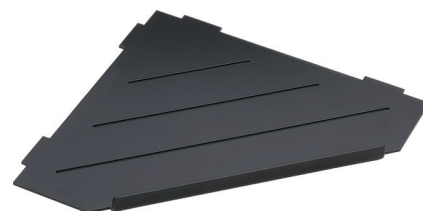

101302450

297 × 15 × 210 mm

Polička do spár, černá
 Shower shelf, black
 Eckduschablage, schwarz
 Душевая полка, черная

Home

17



Nerez | Stainless | Edelstahl | Нержавеющая сталь
Plast | Plastic | Kunststoff | Пластик

Lesk | Polished | Poliert | Блеск
Brus | Brushed | Gebürstet | Мат





101106155

25 × 85 × 34 mm

Háček na dveře

Hook for door

Türhaken

Крючок на дверь



101106225

175 × 87 × 34 mm

Věšák na dveře se 3 háčky

Hanger for door, 3 hooks

Aufhänger für Tür, 3 Haken

Дверная вешалка, 3 крючка



101106235

350 × 87 × 34 mm

Věšák na dveře se 6 háčky

Hanger for door, 6 hooks

Aufhänger für Tür, 6 Haken

Дверная вешалка, 6 крючков



101106154

25 × 85 × 34 mm

Háček na dveře

Hook for door

Türhaken

Крючок на дверь



101106224

175 × 87 × 34 mm

Věšák na dveře se 3 háčky

Hanger for door, 3 hooks

Aufhänger für Tür, 3 Haken

Дверная вешалка, 3 крючка

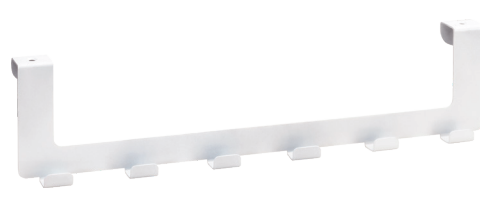

101106234

350 × 87 × 34 mm

Věšák na dveře se 6 háčky

Hanger for door, 6 hooks

Aufhänger für Tür, 6 Haken

Дверная вешалка, 6 крючков



101106150

25 × 85 × 34 mm

Háček na dveře

Hook for door

Türhaken

Крючок на дверь



101106220

175 × 87 × 34 mm

Věšák na dveře se 3 háčky

Hanger for door, 3 hooks

Aufhänger für Tür, 3 Haken

Дверная вешалка, 3 крючка



101106230

350 × 87 × 34 mm

Věšák na dveře se 6 háčky

Hanger for door, 6 hooks

Aufhänger für Tür, 6 Haken

Дверная вешалка, 6 крючков



104315262



104315272

104315262

590 × 435 × 375 mm, 3× 14 l

Odpadkový koš na tříděný odpad

Waste sorting bin

Abfallbehälter für sortierten Abfall

Контейнер для сортировки мусора

104315272

590 × 435 × 375 mm, 2× 20 l

Odpadkový koš na tříděný odpad

Waste sorting bin

Abfallbehälter für sortierten Abfall

Контейнер для сортировки мусора



290000209

195 × 265 × 195 mm (box)

Sada koupelňových doplňků (5 ks), plast, bílý

Set of bathroom accessories (5 pcs.), plastic, white

Set Badezimmerzubehör (5 St.), Kunststoff, weiß

Комплект аксессуаров для ваннх комнат (5 шт.), пластик, белый



290000208

195 × 265 × 195 mm (box)

Sada koupelňových doplňků (5 ks), plast, černý

Set of bathroom accessories (5 pcs.), plastic, black

Set Badezimmerzubehör (5 St.), Kunststoff, schwarz

Комплект аксессуаров для ваннх комнат (5 шт.), пластик, черный



ø 80 × 158 mm

Dávkovač mýdla

Soap dispenser

Seifenspender

Дозатор для жидкого мыла



ø 73 × 130 mm

Držák kartáčků

Toothbrush holder

Zahnbürstenhalter

Держатель зубных щеток



126 × 27 × 90 mm

Mýdenka

Soap dish

Seifenablage

Мыльница



ø 190 × 223 mm, 6 l

Odpadkový koš

Trashbasket

Abfalleimer

Мусорный ящик



ø 102 × 342 mm

WC štětka

Toilet brush

WC-Bürstengarnitur

Ёршик

Nelze koupit samostatně | Can't be sold separately | Nicht separat erhältlich | Отдельно не продается



104206262

51 × 51 × 42 mm

Háček

Hook

Kleiderhaken

Крючок



104206272

51 × 51 × 41 mm

Háček

Hook

Kleiderhaken

Крючок



104206132

25 × 25 × 38 mm

Háček

Hook

Kleiderhaken

Крючок



139106172

47 × 47 × 35 mm

Háček

Hook

Kleiderhaken

Крючок



135006242

174 × 30 × 37 mm

135006252

310 × 30 × 37 mm

Věšák s háčky

Hanger with hooks

Leiste mit Haken

Вешалка с крючками



108022072

Lesk | Polish | Poliert | Блеск

108022075

Mat | Matte | Matt | Мат

80 × 35 × 2 mm

WC



108022062

Lesk | Polish | Poliert | Блеск

108022065

Mat | Matte | Matt | Мат

40 × 85 × 2 mm

Ženy

Women

Damen

Дамы



108022052

Lesk | Polish | Poliert | Блеск

108022055

Mat | Matte | Matt | Мат

40 × 85 × 2 mm













Muži

Men

Herren

Мужчины

Варианты дизайна | Design possibilities | Ausführungsmöglichkeiten | Варианты дизайна

 <p>A/ Круг, блеск Circle, polished Ring, poliert Круг, блеск</p>	<p>B/ Круг, мат Circle, brushed Ring, matt Круг, мат</p>	 <p>75 × 75 mm</p>	<p>C/ Квадрат, блеск Square, polished Quadrat, poliert Квадрат, блеск</p>	<p>D/ Квадрат, мат Square, brushed Quadrat, matt Квадрат, мат</p>
				
<p>111054006 Lesk polished Poliert Блеск ø 75 mm WC</p>	<p>111054001 Lesk polished Poliert Блеск ø 75 mm Invalidé Disabled Behinderte Для инвалидов</p>	<p>111054007 Lesk polished Poliert Блеск ø 75 mm Ženy Women Damen Для женщин</p>	<p>111054002 Lesk polished Poliert Блеск ø 75 mm Muži Men Herren Для мужчин</p>	
				
<p>111054072 Lesk polished Poliert Блеск ø 75 mm Ženy a muži Women and men Damen und Herren Для женщин и мужчин</p>	<p>111054003 Lesk polished Poliert Блеск ø 75 mm Přebalovna Baby nursery room Wickelraum Пеленальный столик</p>	<p>111054004 Lesk polished Poliert Блеск ø 75 mm Sprcha Shower Duschen Душ</p>	<p>111054005 Lesk polished Poliert Блеск ø 75 mm Úklidová místnost Cleaning room Abstellraum Помещение уборочного инвентаря</p>	
				
<p>111054021 Lesk polished Poliert Блеск ø 75 mm Kouření povoleno Smoking Rauchen gestattet Место для курения</p>	<p>111054022 Lesk polished Poliert Блеск ø 75 mm Kouření zakázáno No smoking Rauchen verboten Курить запрещено</p>	<p>111054999 65 × 65 × 2 mm Podložka na zeď pod ikonu Wall pad for icon Unterscheibe für Ikone an die Wand Подложка на стену под табличку</p>		

		A	B	C	D			A	B	C	D
	WC	111054006	111055006	111056006	111057006		Kamera Security camera	111054064	111055064	111056064	111057064
	Invalidé Disabled	111054001	111055001	111056001	111057001		Bar	111054060	111055060	111056060	111057060
	Ženy Women	111054007	111055007	111056007	111057007		Kavárna Cafe	111054061	111055061	111056061	111057061
	Muži Men	111054002	111055002	111056002	111057002		Kuchyně Kitchen	111054062	111055062	111056062	111057062
	Ženy a muži Women and men	111054072	111055072	111056072	111057072		Restaurace Restaurant	111054063	111055063	111056063	111057063
	Přebalovna Baby nursery room	111054003	111055003	111056003	111057003		Eskalátor nahoru Escalator up	111054032	111055032	111056032	111057032
	Sprcha Shower	111054004	111055004	111056004	111057004		Eskalátor dolů Escalator down	111054031	111055031	111056031	111057031
	Úklidová místnost Cleaning room	111054005	111055005	111056005	111057005		Eskalátor Escalator	111054030	111055030	111056030	111057030
	Kouření povoleno Smoking	111054021	111055021	111056021	111057021		Informace Information	111054034	111055034	111056034	111057034
	Kouření zakázáno No smoking	111054022	111055022	111056022	111057022		Parkování Parking	111054036	111055036	111056036	111057036
	Kočárkárna Strollers	111054011	111055011	111056011	111057011		Po schodech nahoru Up stairs	111054039	111055039	111056039	111057039
	Děti Children	111054009	111055009	111056009	111057009		Po schodech dolů Down stairs	111054038	111055038	111056038	111057038
	Šatna Changing room	111054017	111055017	111056017	111057017		Recepce Reception	111054047	111055047	111056047	111057047
	Bazén Swimming pool	111054008	111055008	111056008	111057008		Únikový východ Exit	111054056	111055056	111056056	111057056
	Vířivka Whirlpool	111054018	111055018	111056018	111057018		Vchod Entrance	111054057	111055057	111056057	111057057
	Wellness	111054019	111055019	111056019	111057019		Východ Way out	111054058	111055058	111056058	111057058
	Posilovna Fitness	111054016	111055016	111056016	111057016		Výtah Elevator	111054059	111055059	111056059	111057059
	Modlitebna Chape	111054014	111055014	111056014	111057014		Pokoj Room	111054041	111055041	111056041	111057041
	Kolárna Bicycles	111054012	111055012	111056012	111057012		Šipka Arrow	111054050	111055050	111056050	111057050
	Dětský koutek Playground	111054010	111055010	111056010	111057010		Šipka obousměrná Left right arrow	111054051	111055051	111056051	111057051
	Wifi	111054020	111055020	111056020	111057020		Šipka šikmá levá North west arrow	111054052	111055052	111056052	111057052
	Pokladna Cash desk	111054015	111055015	111056015	111057015		Šipka šikmá pravá North east arrow	111054053	111055053	111056053	111057053
	Koš Trash can	111054013	111055013	111056013	111057013		Pomlčka „až“ Dash „until“	111054042	111055042	111056042	111057042
	Zákaz 1 Interdict 1	111054025	111055025	111056025	111057025		Číslice Number	111054029	111055029	111056029	111057029
	Zákaz 2 Interdict 2	111054026	111055026	111056026	111057026		Patro Floor	111054037	111055037	111056037	111057037
	Zákaz fotografování No photography	111054023	111055023	111056023	111057023		Patro Floor	111054033	111055033	111056033	111057033
	Jídlo zakázáno No food	111054024	111055024	111056024	111057024		Podzemní podlaží Sublevel	111054040	111055040	111056040	111057040
	Zvířata na vodítku Pets on leash	111054027	111055027	111056027	111057027		Nadzemní podlaží Floor	111054035	111055035	111056035	111057035
	Zvířata zakázáno No pets	111054028	111055028	111056028	111057028		Tam Tam	111054054	111055054	111056054	111057054
	Zdravotník Paramedic	111054071	111055071	111056071	111057071		Sem Sem	111054048	111055048	111056048	111057048
	Lékárnička First aid kit	111054067	111055067	111056067	111057067		Push	111054045	111055045	111056045	111057045
	Desinfekce Disinfection	111054065	111055065	111056065	111057065		Pull	111054043	111055043	111056043	111057043
	Zakrytí úst Face masks	111054070	111055070	111056070	111057070		Tam/Push	111054055	111055055	111056055	111057055
	Rozestupy Safe distance	111054069	111055069	111056069	111057069		Sem/Pull	111054049	111055049	111056049	111057049
	Požární hadice Fire hose	111054068	111055068	111056068	111057068		Push/Tam	111054046	111055046	111056046	111057046
	Hasicí přístroj Fire extinguisher	111054066	111055066	111056066	111057066		Pull/Sem	111054044	111055044	111056044	111057044

Coral



158315010

205 × 260 × 205 mm, 5 l

Odpadkový koš s víkem „Soft Close“

Trashbasket „Soft Close“

Abfalleimer „Soft Close“

Мусорный ящик „Soft Close“



158212032

55 × 165 × 65 mm

Držák toaletního papíru pravostranný

Toilet paper holder, rightward

Papierrollenhalter, recht

Держатель туалетной бумаги, правый



Amber



155315010

205 × 260 × 205 mm, 5 l

Odpadkový koš s víkem „Soft Close“

Trashbasket „Soft Close“

Abfalleimer „Soft Close“

Мусорный ящик „Soft Close“

Amber



155212032

55 × 165 × 65 mm

Držák toaletního papíru pravostranný

Toilet paper holder, rightward

Papierrollenhalter, recht

Держатель туалетной бумаги, правый



Hematit



159315013

205 × 260 × 205 mm, 5 l

Odpadkový koš s víkem „Soft Close“

Trashbasket „Soft Close“

Abfalleimer „Soft Close“

Мусорный ящик „Soft Close“



159212032

55 × 165 × 65 mm

Držák toaletního papíru pravostranný

Toilet paper holder, rightward

Papierrollenhalter, recht

Держатель туалетной бумаги, правый



Graphit



156315013

205 × 260 × 205 mm, 5 l

Odpadkový koš s víkem „Soft Close“

Trashbasket „Soft Close“

Abfalleimer „Soft Close“

Мусорный ящик „Soft Close“



156212032

55 × 165 × 65 mm

Držák toaletního papíru pravostranný

Toilet paper holder, rightward

Papierrollenhalter, recht

Держатель туалетной бумаги, правый



156102272

270 × 40 × 110 mm

Polička

Shelf

Ablage

Полочка



Dark



104405200 
120 × 55 × 50 mm
Háček dvojitý
Double hook
Doppelkleiderhaken
Крючок двойной



104506090 
16 × 16 × 30 mm
Háček
Hook
Kleiderhaken
Крючок



104206070 
55 × 190 × 135 mm
Věšák se 3 háčky otočný
Hanger with 3 hooks, swivel
Dreifachhaken drehbar
Тройной крючок поворотный



102308080 
300 × 26 × 115 mm
Polička do sprchy
Shower shelf
Duschregal
Душевая полка



146102270 
270 × 40 × 110 mm
Polička
Shelf
Ablage
Полочка



104204190 
55 × 55 × 420 mm
Držák ručníků dvojitý otočný
Double towel holder swivel
Doppelhandtuchhalter schwenkbar
Полотенцедержатель двойной поворотный



104309320 
85 × 114 × 100 mm, 200 ml
Dávkovač mýdla
Soap dispenser
Seifenspender
Дозатор жидкого мыла

23

Solo



139104232 
50 × 35 × 393 mm
Držák ručníků dvojitý otočný
Double towel holder swivel
Doppelhandtuchhalter schwenkbar
Полотенцедержатель двойной поворотный



139113162 
88 × 375 × 88 mm
WC štětka na postavení/nástěnná
Toilet brush holder free standing/hanging
WC-Bürstengarnitur stehend/hängend
Ёршик подвесной/напольный



139104412 
800 × 25 × 80 mm
Držák ručníků
Towel holder
Handtuchhalter
Полотенцедержатель

Nero



139309310

75 × 116 × 95 mm, 250 ml

Dávkovač mýdla

Soap dispenser

Seifenspender

Дозатор жидкого мыла



135913160

88 × 375 × 88 mm

WC štětka na postavení/nástěnná

WC brush holder free standing/hanging

WC-Bürstengarnitur stehend/hängend

Ёршик подвесной/напольный



White



104204194

55 × 55 × 420 mm

Držák ručníků dvojitý otočný

Double towel holder swivel

Doppelhandtuchhalter schwenkbar

Полотенцедержатель двойной поворотный



Organic



157004101

62 × 42 × 445 mm

Držák ručníků dvojitý otočný

Double towel holder swivel

Doppelhandtuchhalter schwenkbar

Полотенцедержатель двойной поворотный



Beta



132836042

150 × 710 × 255 mm

Stojan s držákem toaletního papíru a WC štětka

Free standing toilet paper and brush holder

Ständer mit Papierrollenhalter und WC-Bürste

Стойка с держателем туалетной бумаги и ёршиком

24

Косметическое зеркало | Cosmetic mirror | Kosmetikspiegel



153301612

195 × 320 × 390 mm

Kosmetické zrcátko oboustranné, 3× zvětšující

Double-sided cosmetic mirror, 3× magnifying

Doppelseitiger Kosmetikspiegel, 3× Vergrößerung

Двустороннее косметическое зеркало, 3× увеличительное



Душевое оборудование | Shower equipment | Dusch - Zubehör

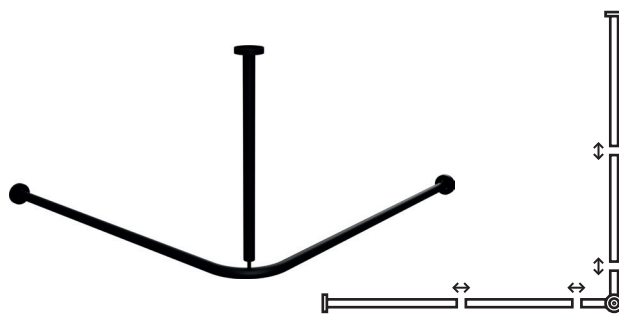

101120110

900 × 500 × 900 mm

Tuč sprchového závěsu rohová skládaná, černá

Corner shower curtain holder assembled, black

Duschvorhangstange steckbar, schwarz

Угловой карниз для душа, разборный, черный



Help program

25



Nerez | Stainless | Edelstahl | Нержавеющая сталь

Ocel | Steel | Stahl | Сталь

Plast | Plastic | Kunststoff | Пластик

Sklo | Glass | Glas | Стекло

Lesk | Polished | Poliert | Блеск

Brus | Brushed | Gebürstet | Мат

Lak | Painted | Lackiert | Лак





301100300

380 × 80 × 106 mm

Madlo s krytkou, černé

Grab bar with flange cover, black

Haltegriff mit Rosette, schwarz

Поручень с декоративными крышками, черный



301100600

680 × 80 × 106 mm

Madlo s krytkou, černé

Grab bar with flange cover, black

Haltegriff mit Rosette, schwarz

Поручень с декоративными крышками, черный



347125010

462 × 120 × 450 mm

Sklopné sprchové sedátko

Reversible shower seat

Duschklappsitz

Откидное сиденье для душа



301607470

100 × 250 × 813 mm

Sklopný úchyt ve tvaru U, černý

Folding grab bar U-shaped, black

Stützklappgriff U-Förmig, schwarz

Откидной поручень U-образный, черный



301707460

103 × 253 × 829 mm

Podpěrné madlo ve tvaru U, černé

U-shape grab bar, black

Stützgriff in U-Form, schwarz

Поручень U-образный, черный



301401030

400 × 600 × 120 mm

Výklopné zrcadlo, černé

Tilting mirror, black

Kippspiegel

Зеркало с поворотной-откидным механизмом, черное

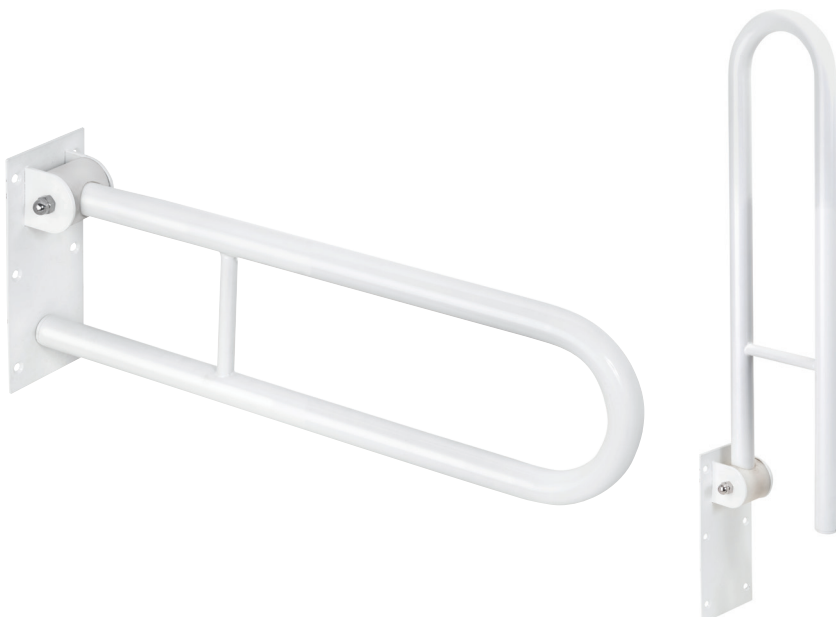

301507804

100 × 250 × 616 mm

301507814

100 × 250 × 816 mm

Sklopný úchyt s aretací, bílý

Folding grab bar with locking, white

Klappgriff mit Arretierung, weiß

Откидной поручень с фиксатором, белый



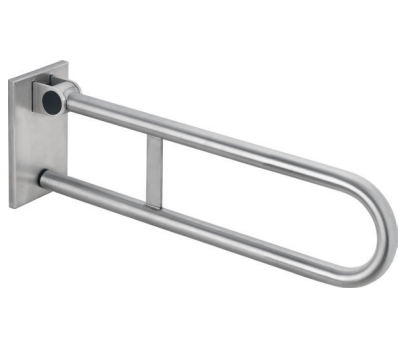

301507825
100 × 250 × 616 mm

301507835
100 × 250 × 829 mm

Sklopný úchyt snímatelný, lesk
Removable folding grab bar, brushed
Abnehmbarer Klappgriff, gebürstet
Съемный откидной поручень, мат



301507821
100 × 250 × 616 mm

301507831
100 × 250 × 829 mm

Sklopný úchyt snímatelný, lesk
Removable folding grab bar, polished
Abnehmbarer Klappgriff, poliert
Съемный откидной поручень, блеск



301507841
120 × 225 × 14 mm

Kotevní deska s krytkou pro madla
301507821, 301507831
The anchor plate with cover flange for grab bar
301507821, 301507831
Ankerplatte mit Abdeckung für Haltegriffe
301507821, 301507831
Монтажная пластина с крышкой для
крепления поручня **301507821, 301507831**



301507845
120 × 225 × 14 mm

Kotevní deska s krytkou pro madla
301507825, 301507835
The anchor plate with cover flange for grab bar
301507825, 301507835
Ankerplatte mit Abdeckung für Haltegriffe
301507825, 301507835
Монтажная пластина с крышкой для
крепления поручня **301507825, 301507835**



301553014
700 × 40 × 95 mm

301553024
800 × 40 × 95 mm

Dveřní úchyt, bílý
Door handle, white
Türgriff, weiß
Дверная ручка, белая



301553015
700 × 40 × 95 mm

301553025
800 × 40 × 95 mm

Dveřní úchyt, brus
Door handle, brushed
Türgriff, gebürstet
Дверная ручка, мат



301553010
700 × 40 × 95 mm

301553020
800 × 40 × 95 mm

Dveřní úchyt, černý
Door handle, black
Türgriff, schwarz
Дверная ручка, черная

